

SLC30 Series — Panel Mounted Annunciators

SLC Series Panel Mounted Annunciators — an Ideal Alternative to Mounting Multiple Pilot Devices

Cluster mounting simplifies panel cutouts and offers a variety of window combination sizes!

Available with incandescent or Superbright LED illumination.

Key features of the SLC30 series include:

- Custom configurations with up to 200 windows
- Five window sizes based on a 30mm grid
- Non-reflective clear lenses
- Incandescent or Superbright LED illumination
- Wide variety of input voltages
- Two color alternate illumination in Red/Green LED



Cert No.
B970213332375

ABS
American
Bureau of
Shipping



Style F
(30mm x 30mm)



Style H
(30mm x 60mm)



Style L
(30mm x 90mm)



Style V
(60mm x 30mm)



Style G
(60mm x 60mm)



Staggered Terminals:
increased safety
and serviceability

Switches & Pilot Lights

Display Lights

Relays & Sockets

Timers

Terminal Blocks

Circuit Breakers

Specifications

Light Source		LED	Incandescent	
Nominal Voltages	Full Voltage	6, 12, 24V AC/DC	6, 12, 18, 24, 30V AC/DC	
	Transformer	120, 240V AC	120, 240V AC	
	DC-DC Conv.	110V DC	110V DC	
Colors		Amber, Green, Red, Yellow, Blue (24V only), White, dual color Red/Green (24V only)	Amber, Green, Red, Yellow, Blue, White	
Lamp Type		Surface (Chip type) LED cluster	BA9S/13 (T3-1/4) bayonet base (1W)	
Current Consumption	6V DC	Red (R), Green (G), Yellow (Y), Amber (A), White (W): 80mA		
	12V DC	Red (R), Green (G), Yellow (Y), Amber (A), White (W): 40mA		
	24V DC	Red (R), Green (G), Yellow (Y), Amber (A), White (W), Blue (S): 20mA		
Available Window Sizes		"F" 30x30mm "H" 30x60mm "L" 30x90mm "V" 60x30mm "G" 60x60mm		
Insulation Resistance		More than 100 MΩ by a 500V DC megger		
Degree of Protection		IP20 (for indoor use only), NEMA 1		
Dielectric Strength		2,000V AC direct (2,500V AC transformer, 1 minute)		
Operating Temperature		- 20° to +40°C; 15-90% relative humidity (- 10° to +40°C DC-DC converter)		
Material of Marking Plate and Color Screen		Polycarbonate		
Termination		M3.5 screw with captive sems plate (Check terminals: M3 screw with captive sems plate on applicable units)		
Maximum Size		Full voltage 10 rows, 20 columns (200 windows) Transformer and DC/DC converter (50 windows)		
Recommended Wire Size		22-14 AWG x2 (2mm ² x 2)		
Approvals		Cert. No. B970213332375 Bauart geprüft	UL Recognized File No. E68961 	CSA Certified File No. LR48366

Specifications

Switches & Pilot Lights

Display Lights

Relays & Sockets

Timers

Terminal Blocks

Circuit Breakers



Part Numbers (assembled)

Part Number Guide

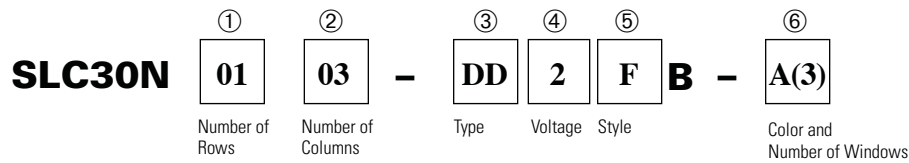

Switches & Pilot Lights

Display Lights

Relays & Sockets

Timers

Terminal Blocks

Circuit Breakers

Description		Code	Remark
① Number of Rows		01, 02, 03, 04, 05, 06, 07, 08, 09, 10	10 row maximum (always expressed in terms of "F" size windows)
② Number of Columns		01, 02, 03, 04, 05, 06, 07, 08, 09, 10, 11, 12, 13, 14, 15, 16, 17, 18, 19, 20	20 column maximum (always expressed in terms of "F" size windows)
③ Type	LED	Full voltage	DD 6V, 12V, 24V
		Full voltage with check terminal	DHM 24V only
		Full voltage 2 color (Red/Green)	DW 24V only
		Transformer	TD 120V, 240V AC
		DC-DC converter	CD 110V DC only
	Incandescent	Full voltage	DS 6V, 12V, 18V, 24V, 30V
		Transformer	TS 120V, 240V
④ Voltage	6V AC/DC	6 Type DD or DS	
	12V AC/DC	1 With Type DD or DS	
	18V AC/DC	8 Type DS only	
	24V AC/DC	2 Type DD, DW, DS or DHM	
	30V AC/DC	3 Type DS only	
	120V AC	12 Type TD or TS	
	240V AC	24 Type TD or TS	
	110V DC	1 With Type CD	
	No lamp	99 Type DS only	
⑤ Style	Square	F 30x30mm	
	Horizontal rectangle	H 30x60mm	
	Horizontal rectangle with barrier	H2	
	Large horizontal rectangle	L 30x90mm	
	Vertical rectangle	V 60x30mm	
	Large square	G 60x60mm	
	Combination	M Fill out order form on next page	
⑥ Color (number of windows)	Amber	A	
	Green	G	
	Red	R	
	Blue	S (LED version: 24V only)	
	White	W	
	Yellow	Y	

- 1. Secondary voltage on transformers and DC-DC converters is 24V.
- 2. To specify arrangement of varying window sizes and colors, use the order form on the next page.
- 3. Drawing required for any units ordered with engraving.
- 4. Incandescent models use color screen and marking plate, LED models use 2 marking plates (no color screen).

Purchase Order No. _____ Date _____ Sheet _____ of _____

Fill in Part Number Below:

Contact _____
 Company _____
 Phone # _____
 Ship to _____

 City/State/Zip _____

A	Number of Amber	<input type="text"/>
G	Number of Green	<input type="text"/>
R	Number of Red	<input type="text"/>
S	Number of Blue	<input type="text"/>
W	Number of White	<input type="text"/>
Y	Number of Yellow	<input type="text"/>

Rows
 Columns
 Operating Voltage Style Code
 Type Code

SLC30N —

Note: Convert all window styles to the style F (basic unit size).

- Remarks:**
- F = One Window
 - H = Two Windows Wide
 - L = Three Windows Wide
 - V = Two Windows High
 - G = Two x Two
 - M = Multiple Combination

Remarks:



THIS SIDE UP ↑

First Window (upper, left-hand corner of panel)

COLUMNS ↓

ROWS ←

Quantity _____ Note: All units ordered with one order form must be identical										
For engraving information, see page 715.										
For information on how to complete the order form or to view examples, see the following page.										
↑ THIS SIDE UP ↑										

Order Form

1. For part number development, see the previous page.
2. Panel cutout dimensions are on page 697.
3. Additional ordering information is on page 696.



How to complete SLC30N Series annunciator order form:

1. Draw the SLC30N layout in the Order Form as per customer requirements. Define the boundaries of each window (F, V, H, L or G Style) and of complete annunciator panel by heavy border lines. Specify each window color with appropriate designation (eg: G for Green, R for Red, etc). See Example 1 below:

Example 1

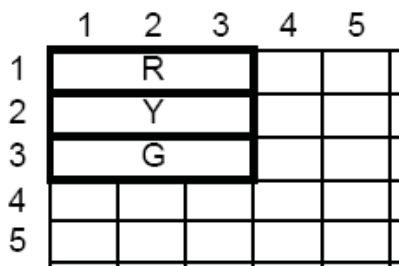

2. Count number of rows and columns. eg: Example 1, Rows: 03 and Columns: 03

SLC30N-0303

3. Determine the type of illumination required. eg: "DD" for LED full voltage type illumination.

SLC30N-0303-DD

4. Determine the voltage code. eg: "2" for 24V AC/DC.

SLC30N-0303-DD2

5. Determine window style. eg: "L" style windows as shown in Example 1.

SLC30N-0303-DD2LB*

*B denotes black frame

6. Count the number of different colored windows in the annunciator. Example 1 has 1 Red L-style (30x90mm) window, 1 Yellow L-style window and 1 Green L-style window.

SLC30N-0303-DD2LB-R(1)Y(1)G(1)

7. Now your part number is complete, please fill out contact information and fax or email the form to IDEC Customer Service for order processing. If you would like to get annunciator windows engraved, please see the information on page 715 and send us your engraving information. If you have any questions, please contact IDEC Technical Support or for additional information, view examples 2 and 3.:

Example 2

Rows=03; Columns= 03; F Style Windows (30x30mm); LED Full Voltage 24V AC/DC Illumination. Part number **SLC30N-0303-DD2FB-R(3)Y(3)G(3)**.

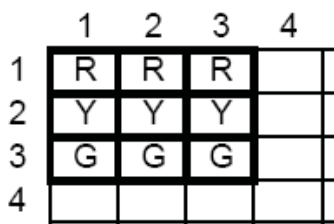

Example 3:

Rows = 04; Columns = 05; M = combination of various window styles(F, H, L V and G Style) ; LED Full Voltage 24V AC/DC Illumination.

Part number **SLC30N-0405-DD2MB-A(1)R(2)Y(1)G(1)W(2)S(2)**.

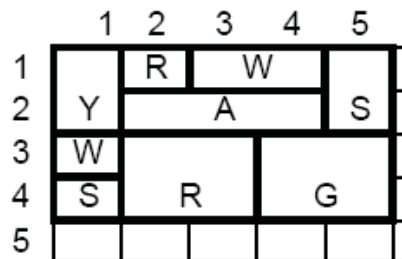

Dimensions

Panel Cut-Out Dimensions

No. of Rows	No. of Columns		1	2	3	4	5	6	7	8	9	10	11	12	13	14	15	16	17	18	19	20
	Overall Panel Width Dimension →		1.654" (42mm)	2.853" (72mm)	4.016" (102mm)	5.197" (132mm)	6.378" (162mm)	7.559" (192mm)	8.740" (222mm)	9.921" (252mm)	11.102" (282mm)	12.283" (312mm)	13.465" (342mm)	14.646" (372mm)	15.827" (402mm)	17.008" (432mm)	18.189" (462mm)	19.370" (492mm)	20.551" (522mm)	21.732" (552mm)	22.913" (582mm)	24.094" (612mm)
	Overall Height ↓	Cut-out Ht ↓	Cut-out Wd →	1.378" (35mm)	2.559" (65mm)	3.740" (95mm)	4.921" (125mm)	6.102" (155mm)	7.283" (185mm)	8.465" (215mm)	9.646" (245mm)	10.827" (275mm)	12.008" (305mm)	13.189" (335mm)	14.370" (365mm)	15.551" (395mm)	16.732" (425mm)	17.913" (455mm)	19.094" (485mm)	20.276" (515mm)	21.457" (545mm)	22.638" (575mm)
1	1.654" (42mm)	1.378" (35mm)	1	2	3	4	5	6	7	8	9	10	11	12	13	14	15	16	17	18	19	20
2	2.853" (72mm)	2.559" (65mm)	2	4	6	8	10	12	14	16	18	20	22	24	26	28	30	32	34	36	38	40
3	4.016" (102mm)	3.740" (95mm)	3	6	9	12	15	18	21	24	27	30	33	36	39	42	45	48	51	54	57	60
4	5.197" (132mm)	4.921" (125mm)	4	8	12	16	20	24	28	32	36	40	44	48	52	56	60	64	68	72	76	80
5	6.378" (162mm)	6.102" (155mm)	5	10	15	20	25	30	35	40	45	50	55	60	65	70	75	80	85	90	95	100
6	7.559" (192mm)	7.283" (185mm)	6	12	18	24	30	36	42	48	54	60	66	72	78	84	90	96	102	108	114	120
7	8.740" (222mm)	8.465" (215mm)	7	14	21	28	35	42	49	56	63	70	77	84	91	98	105	112	119	126	133	140
8	9.921" (252mm)	9.646" (245mm)	8	16	24	32	40	48	56	64	72	80	88	96	104	112	120	128	136	144	152	160
9	11.102" (282mm)	10.827" (275mm)	9	18	27	36	45	54	63	72	81	90	99	108	117	126	135	144	153	162	171	180
10	12.283" (312mm)	12.008" (305mm)	10	20	30	40	50	60	70	80	90	100	110	120	130	140	150	160	170	180	190	200
Total Number of Windows (equivalent to style F—basic unit size)																						

1. The number of rows and columns refers to styles equivalent to style F (basic unit size).
 For styles H, L, V, and G, convert into style F (basic unit size) equivalents.
 Style H: 1 window high (1 row) x 2 windows wide (2 columns)
 Style V: 2 windows high (2 rows) x 1 window wide (1 column)
 Style L: 1 window high (1 row) x 3 windows wide (3 columns)
 Style G: 2 windows high (2 rows) x 2 windows wide (2 columns)
 Example: 18 windows = 3 windows high (3 rows) x 6 windows wide (6 columns)
 Overall dimension (H x W): 4.016" x 7.559" (102 x 192mm)
 Panel cut-out (H x W): 3.740" x 7.283" (95 x 185mm)
 Tolerance: +0.039" (1mm), -0
 2. For part numbering information, see page 694.

Window Dimensions

Window Style	Style F	Style H	Style L	Style V	Style G	
Appearance						
Window Size	Illumination Face (H x W)	1.181" x 1.181" (30 x 30mm)	1.181" x 2.362" (30 x 60mm)	1.181" x 3.543" (30 x 90mm)	2.362" x 1.181" (60 x 30mm)	2.362" x 2.362" (60 x 60mm)
	Lens (H x W)	1.102" x 1.102" (28 x 28mm)	1.102" x 2.283" (28 x 58mm)	1.102" x 3.432" (28 x 88mm)	2.283" x 1.102" (58 x 28mm)	2.283" x 2.283" (58 x 58mm)
	Marking Plate (H x W x t)	1.062" x 1.062" x 0.04" (27 x 27 x 1.0mm)	1.062" x 2.244" x 0.04" (27 x 57 x 1.0mm)	1.062" x 3.425" x 0.04" (27 x 87 x 1.0mm)	2.244" x 1.062" x 0.04" (57 x 27 x 1.0mm)	2.244" x 2.244" x 0.04" (57 x 57 x 1.0mm)
	Color Screen (H x W x t)	1.062" x 1.062" x 0.04" (27 x 27 x 1.0mm)	1.062" x 2.244" x 0.04" (27 x 57 x 1.0mm)	1.062" x 3.425" x 0.04" (27 x 87 x 1.0mm)	2.244" x 1.062" x 0.04" (57 x 27 x 1.0mm)	2.244" x 2.244" x 0.04" (57 x 57 x 1.0mm)
	Engraving Area	0.984" x 0.984" (25 x 25mm)	0.984" x 2.165" (25 x 55mm)	0.984" x 3.346" (25 x 85mm)	2.165" x 0.984" (55 x 25mm)	2.165" x 2.165" (55 x 55mm)

Switches & Pilot Lights

Display Lights

Relays & Sockets

Timers

Terminal Blocks

Circuit Breakers

Dimensions, continued

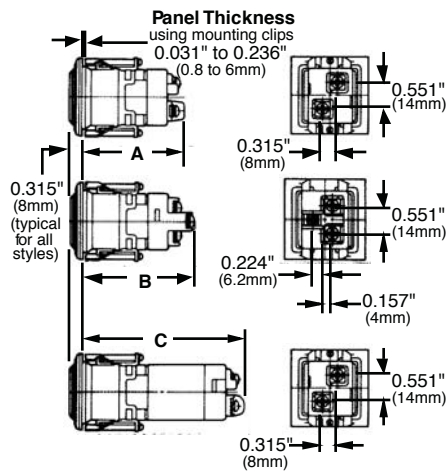
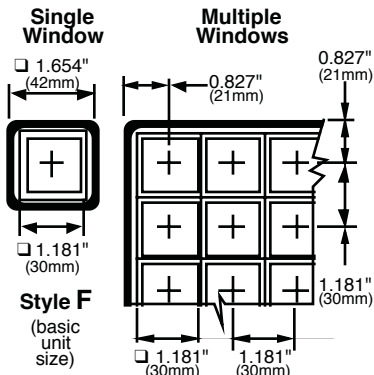

Styles F, H, L, V, G:
 Single Window (right)
 Multiple Windows (below)

	Description	LED	Incandescent
A	Full voltage	2.146" (54.5mm)	2.264" (57.5mm)
B	Full voltage LED 2-color alternate	2.343" (59.5mm)	—
C	Transformer	3.228" (82mm)	—
	DC-DC converter	3.228" (82mm)	—
	Transformer	—	3.228" (82mm)
	Terminals (X1, X2)	M3.5 screw	
	Check terminal (C)	M3 screw	
	Same terminals, adjacent windows	1.181" (30mm) centers	

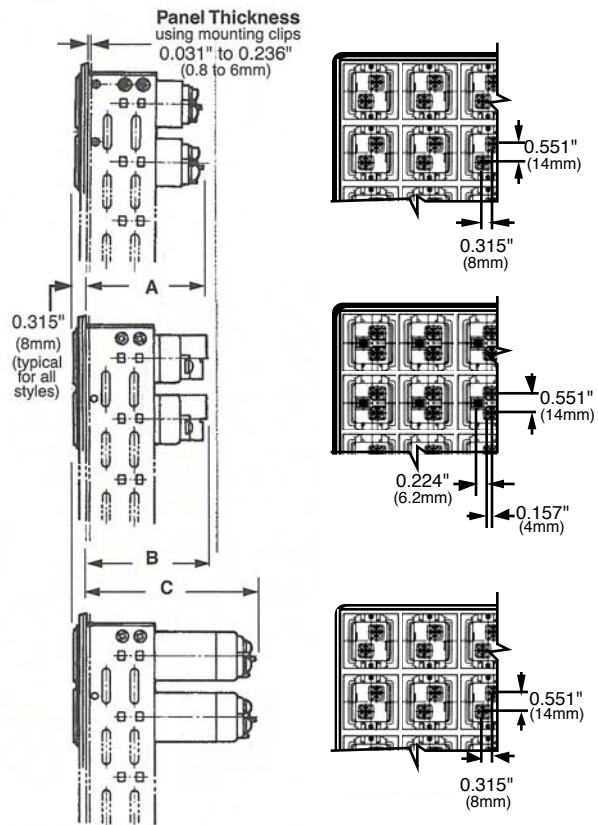
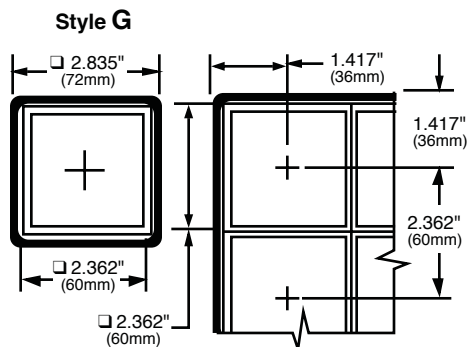
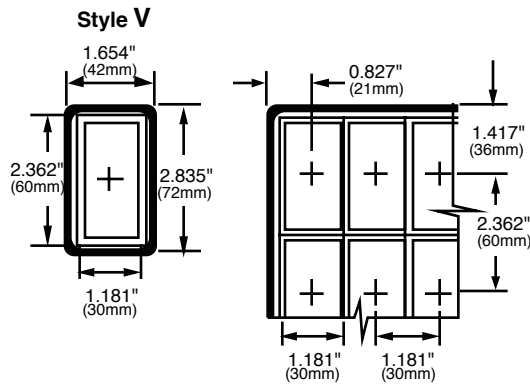
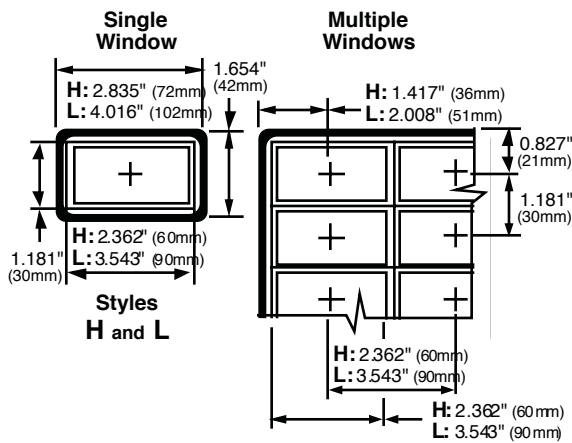

Switches & Pilot Lights

Display Lights

Relays & Sockets

Timers

Terminal Blocks

Circuit Breakers

Dimensions, continued

JUMPERS

Thickness = 0.020" (0.5mm)

Centers:

SLC30 = 1.181" (30mm)

SLC40 = 1.575" (40mm)

± 0.004" (0.1mm)

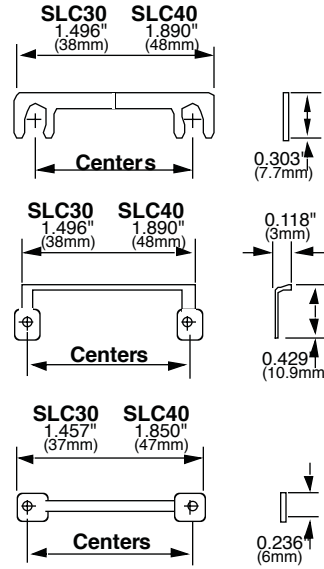

Instructions

Estimating Weights

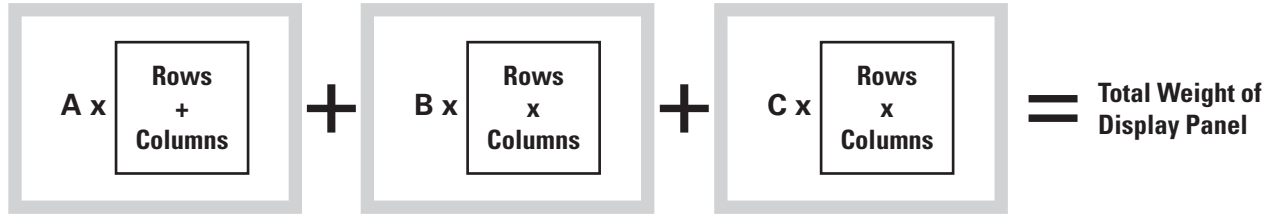

1. Make sure that the panel thickness is sufficient to support the total weight of the display panel(s).

A Frame Weight	B Housing Weight	Full Voltage	Transformer (incandescent/LED)	DC-DC Converter (LED only)
		C Lamp/LED Weight (includes lamp/LED)		
0.68oz (22g)	0.53oz (17g)	0.65oz (21g)	2.36oz (76g)	1.77oz (52g)

2. Weights are approximate.

Example:

SLC30N-0304-DD2FB

Total weight = A (rows + columns) + B (rows x columns) + C (rows x columns)

Total weight = 0.68 (3+4) + 0.53 (3x4) + 0.65 (3x4) = 19.92 oz

Engraving Information

Part Numbers: SLC30 Engraving Plates

Window Type	Part No.	Character Size	Maximum Characters per Line	Maximum Lines
F 30x30mm	SLC-3PF	7/32	7	3
		3/16	7	3
		5/32	9	4
		9/64	9	4
		1/8	10	4
H 30x60mm	SLC-3PH	5/16	8	2
		7/32	13	3
		5/32	17	4
L 30x90mm	SLC-3PL	5/16	14	2
		7/32	20	3
		5/32	26	4
V 60x30mm	SLC-3PV	5/16	4	4
		7/32	6	6
		5/32	8	8
G 60x60mm	SLC-3PG	5/16	9	4
		7/32	12	6
		5/32	16	8

Part Numbers SLC40 Engraving Plates

F 40x40mm	SLC-4PF	5/16	5	2
		7/32	8	4
		5/32	11	5
H 40x80mm	SLC-4PH	5/16	12	2
		7/32	17	4
		5/32	22	5
L 40x120mm	SLC-4PL	5/16	18	2
		7/32	26	4
		5/32	34	5
V 80x40mm	SLC-4PV	5/16	5	6
		7/32	8	7
		5/32	11	12

Engraving Size Samples

5/16" size

7/32" size

3/16" size

5/32" size

9/64" size

1/8" size

Engraving Size Samples

5/16" size

7/32" size

5/32" size

Engraving Example

Engraving information can be provided in two ways:

Method 1

If you have created your own SLC annunciator layout and there is enough space to write engraving information, please print out a copy of the layout and write what you would like to be engraved in respective window. Attach this with the Order Form and send it to IDEC Customer Service for processing.

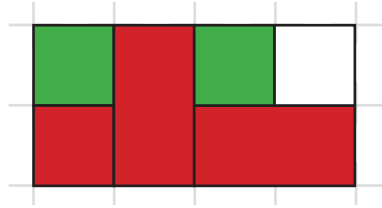

Engraving Layout

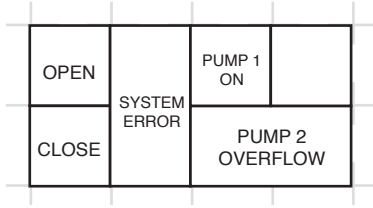

SLC Annunciator Layout

Method 2

If you are using the Order Form from the IDEC Automation Catalog and do not have enough space to list engraving information, you can number the top right corner of the window you would like to be engraved.

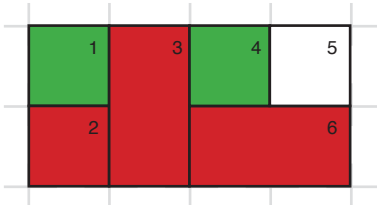

Keeping engraving window type, character size, maximum character per line and maximum number of lines in perspective, create a table (see Engraving Table Example shown below). Please attach the Table along with SLC annunciator layout and send it to IDEC Customer Service for processing.

Engraving Table Example

Window	Font Size	Engrave
1	7/32"	"OPEN"
2	7/32"	"CLOSE"
3	7/32"	"SYSTEM" "ERROR "
4	3/16"	"PUMP 1" "ON"
5		NO ENGRAVING
6	5/32"	"PUMP 2" "OVERFLOW"

Using method 1 or 2, the final engraved panel will look as below:

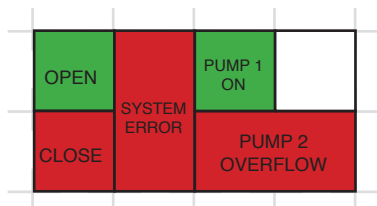

Final Engraved Panel

Accessories

Description		Application		Part No.	Remarks
Lenses		SLC30 incandescent, LED	F	SLC-3LF-(UL)	A lens is included with each window on assembled units
			H and V	SLC-3LH-(UL)	
			L	SLC-3LL-(UL)	
		SLC40 incandescent, LED	F	SLC-4LF-(UL)	
			H and V	SLC-42H-(UL)	
			L	SLC-4LL-(UL)	
Color Screens		SLC30 incandescent	F	SLC-3PF-*(UL)	Specify color code in place of asterisk (*): A = Amber C = Transparent G = Green (incandescent) R = Red S = Blue W = White Y = Yellow A color screen and marking plate are included with each window of assembled incandescent units
			H and V	SLC-3PH-*(UL)	
			L	SLC-3PL-*(UL)	
		SLC40 incandescent	F	SLC-4PF-*(UL)	
			H and V	SLC-4PH-*	
			L	SLC-4PL-*(UL)	
Marking Plates		SLC30 incandescent, LED	F	SLC-3PF-□-(UL)	Specify color code in place of square (□): C = Transparent (LED) W = White (incandescent) WL = White (LED) Two marking plates are included with each window of assembled LED units; LED units do not use color screens
			H and V	SLC-3PH-□-(UL)	
			L	SLC-3PL-□-(UL)	
		SLC40 incandescent, LED	F	SLC-4PF-□-(UL)	
			H and V	SLC-4PH-□-(UL)	
			L	SLC-4PL-□-(UL)	
Lens Frames		SLC30 incandescent only	F	SLC-3WF-B	A lens frame is included with each window on assembled units
			H	SLC-3WH-B	
			V	SLC-3WV-B	
			L	SLC-3WL-B	
			G	SLC-3WG-B	
		SLC30 LED only	F	SLC-3WF-BL	
			H	SLC-3WH-BL	
			V	SLC-3WV-BL	
			L	SLC-3WL-BL	
			G	SLC-3WG-BL	
		SLC40 incandescent only	F	SLC-4WF-B	
			H	SLC-4WH-B	
			V	SLC-4WV-B	
			L	SLC-4WL-B	
		SLC40 LED only	F	SLC-4WF-BL	
V	SLC-4WV-BL				
L	SLC-4WL-BL				

Switches & Pilot Lights

Display Lights

Relays & Sockets

Timers

Terminal Blocks

Circuit Breakers



Switches & Pilot Lights

Display Lights

Relays & Sockets

Description		Application		Part No.	Remarks
Incandescent Lamps	BA9S/13 (1W) 	SLC30 incandescent only	BA9S/13 lamp base	IS-6	6.3V, 1W; operating voltage: 5 to 6V AC/DC
				IS-12	12V, 1W; operating voltage: 9 to 12V AC/DC
				IS-24	24V, 1W; operating voltage: 18 to 24V AC/DC
				IS-30	30V, 1W; operating voltage: 24 to 30V AC /DC
	E12/15 (2W) 	SLC40 incandescent only	E12/15 lamp base	LE-6	6.3V, 2W; operating voltage: 5 to 6V AC/DC
				LE-8	18V, 2W; operating voltage: 12 to 18V AC/DC
				LE-2	24V, 2W; operating voltage: 18 to 24V AC/DC
				LE-3	30V, 2W; operating voltage: 24 to 30V AC/DC
LED Lamps		SLC30 LED only 1-color	6V AC/DC	SLC-6SP*	Specify color code in place of asterisk (*): A = Amber G = Green R = Red S = Blue (available in 24V version only) W = White Y = Yellow
			12V AC/DC	SLC-1SP*	
			24V AC/DC	SLC-2SP*	
		SLC30 LED only 2-color: Red/Green	24V AC/DC	SLC-2SP-R/G	
			SLC40 LED only 1-color	6V AC/DC	
		12V AC/DC		SLC-1EP*	
		24V AC/DC		SLC-2EP*	
		SLC40 LED only 2-color: Red/Green	24V AC/DC	SLC-2EP-R/G	





Replacement Parts

Full Voltage Models		Description	Type	Part Number
SLC30 	Incandescent	Incandescent	DS	SLC-3DS
		Standard LED	DD	SLC-3DH
	LED	LED w/ Check Terminal	DHM	SLD-3DHM
		Dual Color LED	DW	SLD-3DW
SLC 40 	Incandescent	Incandescent	DE	SLC-4DE
		Incandescent w/ Check Terminal	DEM	SLC-4DEM
	LED	Standard LED	DD	SLC-4DH
		LED w/ Check Terminal	DHM	SLC-4DHM
		Dual Color LED	DW	SLC-4DHW
		Step Down Models		Description
SLC30  	Incandescent	Incandescent xfrmr, 120V AC	TS12	SLC-3TS120
		Incandescent xfrmr, 240V AC	TS24	SLC-3TS240
	LED	LED xfrmr, 120V AC	TD12	SLC-3TP120
		LED xfrmr, 240V AC	TD24	SLC-3TP240
		LED DC-DC converter, 110V DC	CD1	SLC-3CP1
SLC40  	Incandescent	Incandescent xfrmr, 120V AC	TE12	SLC-4TE12
		Incandescent xfrmr, 240V AC	TE24	SLC-4TE240
	LED	LED xfrmr, 120V AC	TD12	SLC-4TP120
		LED xfrmr, 240V AC	TD24	SLC-4TP240
		LED DC-DC converter, 110V DC	CD1	SLC-4CP1

Timers

Terminal Blocks

Circuit Breakers

Description	Application	Part No.	Remarks
Lamp Holder Tool	SLC30 and SLC40 incandescent	OR-55	Rubber tool eases the removal of incandescent lamps
Tab Terminal Adaptors 	Used for wiring quick-connect terminals	TW-FA1	#250 tab terminal (W x H): 0.250" x 0.031" (6.35 x 0.8mm) single tab
Jumpers 	SLC30	X1 terminal (spade)	SLC-JP30
		X2 terminal (ring)	SLC-JP33
		C terminal (ring)	SLC-JP32
	SLC40	X1 terminal (spade)	SLC-JP40
		X2 terminal (ring)	SLC-JP41
		C terminal (ring)	SLC-JP42
Total number of jumpers equals total number of style F window equivalents			
Mounting Clip 	All SLCs	SLC-3K1	Mounting clips are included with the panel (see page 721 for details about quantity and placement).
Marking Strip		BNM2	White glossy paper with adhesive back (the dimensions are given below); the marking strip can be stuck to the terminal transformer or directly to the units for identification of the unit or circuit number; Sticker dimension (W x L): 0.197" x 393.701" (5 x 10,000mm)
Finger-Safe Terminal Covers 	Use with SLC30 types DD, TD, CD, DS and TS	SLC30-VL3	
	Use with all SLC30 types DHM and DW	SLC30-VL6	
	Use with SLC40 types DD, TD, CD, DE and TE	HW-VL3	
	Use with SLC40 types DHM, DW, and DEM	SLC40-VL6	

Switches & Pilot Lights

Display Lights

Relays & Sockets

Timers

Terminal Blocks

Circuit Breakers

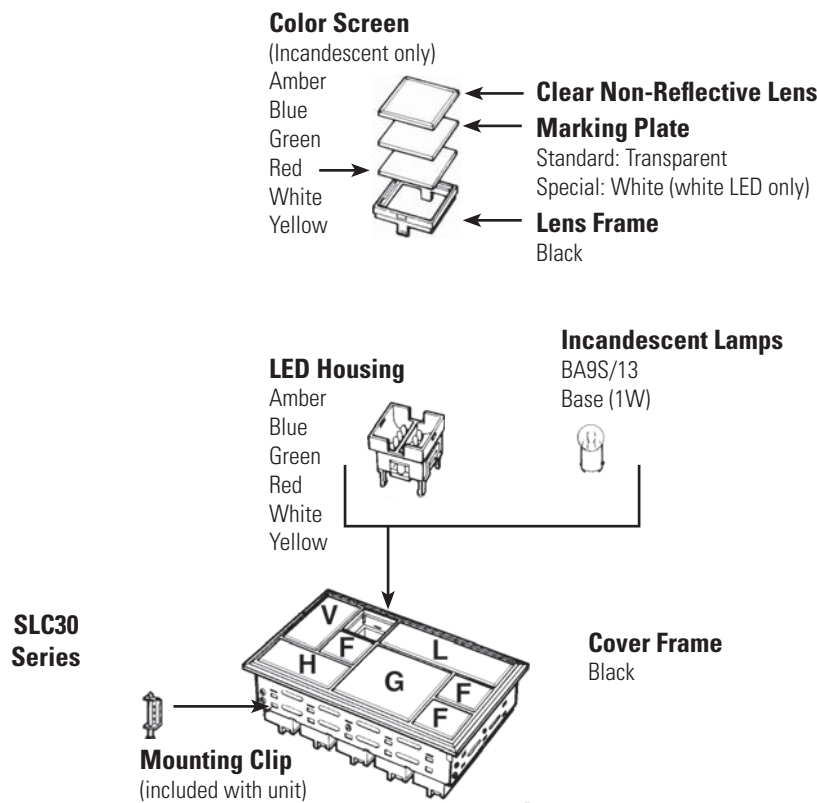

SLC Series Installation Instructions

Installation Notes

1. Since lamps generate heat, it is recommended that ventilation be provided for cooling when more than ten lamps are lit continuously.
2. A lower number of windows is specified for multiple transformer and DC-DC converter units (50 maximum, instead of 200 as for full voltage only). This is done to avoid damage which may result from excessive heat generation when all lamps are lit simultaneously.
3. When multiple units are panel mounted, determine panel thickness so that the combined weight of all units and connecting wires can be supported.
4. Multiple units are not designed for continuous, simultaneous lighting of all lamps. However, it is possible to conduct a lamp test with all lamps lit simultaneously for a period of up to 40 minutes.
5. Before removing the LED unit, turn the power supply off.
6. DC-rated voltages for LED units are complete direct current voltages. Make sure to check the measuring instruments and compensate for any error in the measured, full-wave rectified or pulsating voltages.
7. To ensure brightness and long life of LED units, keep the DC power voltage within the operating voltage range.

LED Operating Voltage Range: 24V AC/DC ± 10%

Terminal Arrangements (LED units)

For full voltage (1- and 2-color) and DC-DC converter LED units, terminal X1 is positive and terminal X2 is negative. Make sure to observe polarity when wiring.

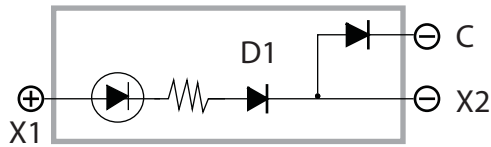

For 2-color alternate units, terminal X1 is positive, and terminals X2 and C (check terminal) are negative.

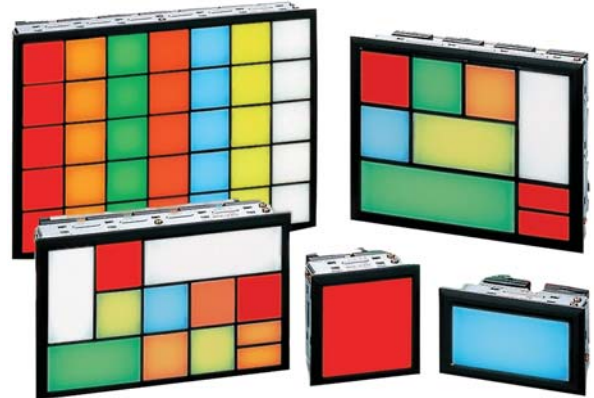
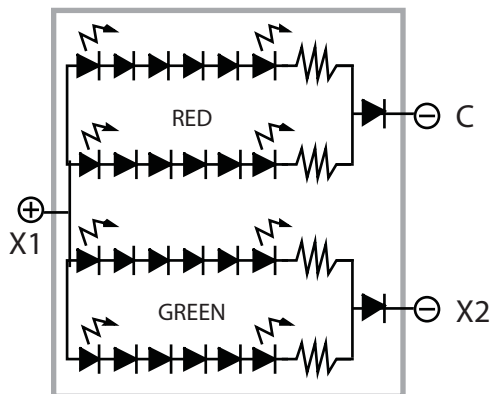
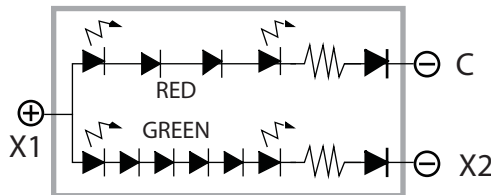

SLC30/SLC40 Full Voltage DC-DC Converter

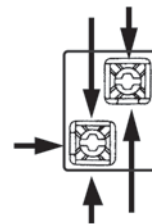

SLC30/SLC40 Transformer

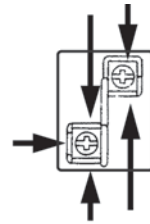

SLC30/SLC40 Full Voltage with Check Terminal

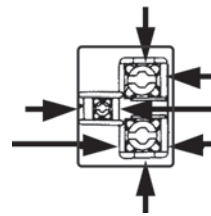

SLC30/40 2-color LED (alternating)

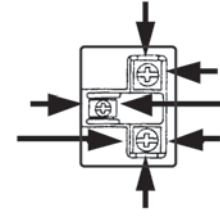

SLC30



SLC40



Installation Instructions, continued

Removing Windows

SLC30: To remove a window, insert the tip of a small screwdriver into the slot under the lens frame and gently press down on the screwdriver.

SLC40: To remove an extended window, pull on the top as if to extend the unit; then continue pulling until the unit comes out of the housing. All units are shipped with windows retracted. When transporting units, make sure windows are pushed in fully. After windows are installed, they can be extended as shown in Figure 1.



Figure 1: SLC40

Removing Lens, Color Screen, and Marking Plate

The lens has two retaining projections on the right and two on the left. To remove the lens, color screen, and marking plate from the lens frame, push open the lens frame with both hands as shown in Figure 2.

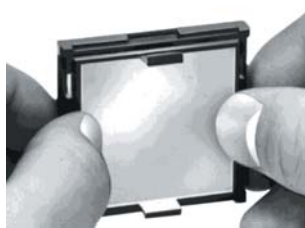

Figure 2: SLC30 and SLC40

The lens can also be removed by inserting a screwdriver into one of the sides with recesses. Since the lens has an orientation, be sure to insert the screwdriver in the direction shown in Figures 3 and 4.

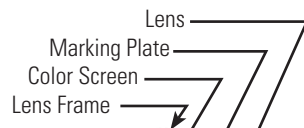

Figure 3: SLC30
Figure 4: SLC40

Removing Lens, Color Screen, and Marking

First, install the marking plate and color screen into the lens frame. To install the lens, insert its retaining projections into the recesses inside the lens

Figure 5: SLC30 and SLC40

frame, and press the lens into the lens frame as shown in Figure 5.



Figure 8: SLC40

SLC Series Installation Instructions, continued

Number of Mounting Clips Included

Columns	1 or 2		3 to 8		9 to 15	16 to 20 *
Rows	Full Voltage	Others	Full Voltage	Others	All Types	All Types
1 or 2	2		4		6	8
3 to 6	4	6	6	8	8	10
7 to 10 (SLC30 only)	6	8	8		10	12

 * SLC30 series only

Recommended Mounting Clip Positions

Columns	1 or 2		3 to 8		9 to 15	16 to 20*
Rows	Full Voltage	Others	Full Voltage	Others	All Types	All Types
1 or 2	2 Clips		4 Clips		6 Clips	8 Clips
3 to 6	4 Clips	6 Clips	6 Clips	8 Clips	8 Clips	10 Clips
7 to 10 (SLC30 only)	6 Clips	8 Clips	8 Clips		10 Clips	12 Clips

Assembly Order for Lamp On/Lamp Off Colors

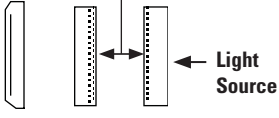
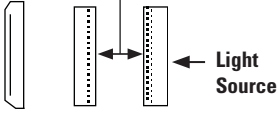
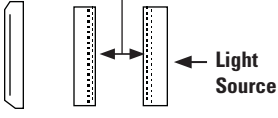
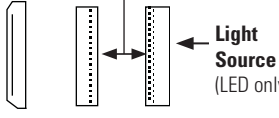
Lamp On: Amber, Blue Green, Red, Yellow		Lamp On: White		Lamp On: Red/Green			
Lamp Off: Desired Color		Lamp Off: White		Lamp Off: White			
<p>Matte Surface (non-shiny)</p>  <p>Light Source</p> <p>Lens Color Screen: Marking Plate: Any Color White</p>		<p>Matte Surface (non-shiny)</p>  <p>Light Source</p> <p>Lens Marking Plate: Color Screen: White Any Color</p>		<p>Matte Surface (non-shiny)</p>  <p>Light Source</p> <p>Lens Marking Plate: Color Screen: White White</p>		<p>Matte Surface (non-shiny)</p>  <p>Light Source (LED only)</p> <p>Lens Marking Plate: Color Screen: White White</p>	

Switches & Pilot Lights

Display Lights

Relays & Sockets

Timers

Terminal Blocks

Circuit Breakers